

# PSM 350 U



## YARI OTOMATİK TESTERE TEZGAHI SEMI AUTOMATIC BANDSAW MACHINE



**MALZEME SIKMA SİSTEMİ**  
MATERIAL CLAMPING SYSTEM

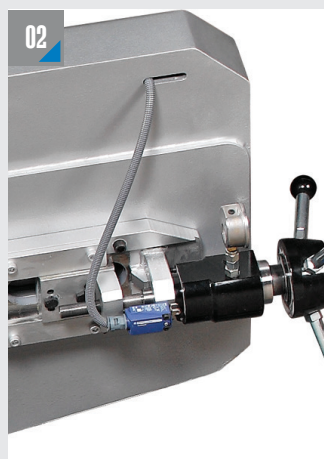

**ŞERİT GERDİRME SİSTEMİ**  
BLADE TENSIONING



**KUMANDA PANELİ**  
CONTROL PANEL



**AÇILI KESİM**  
MITER CUTTING





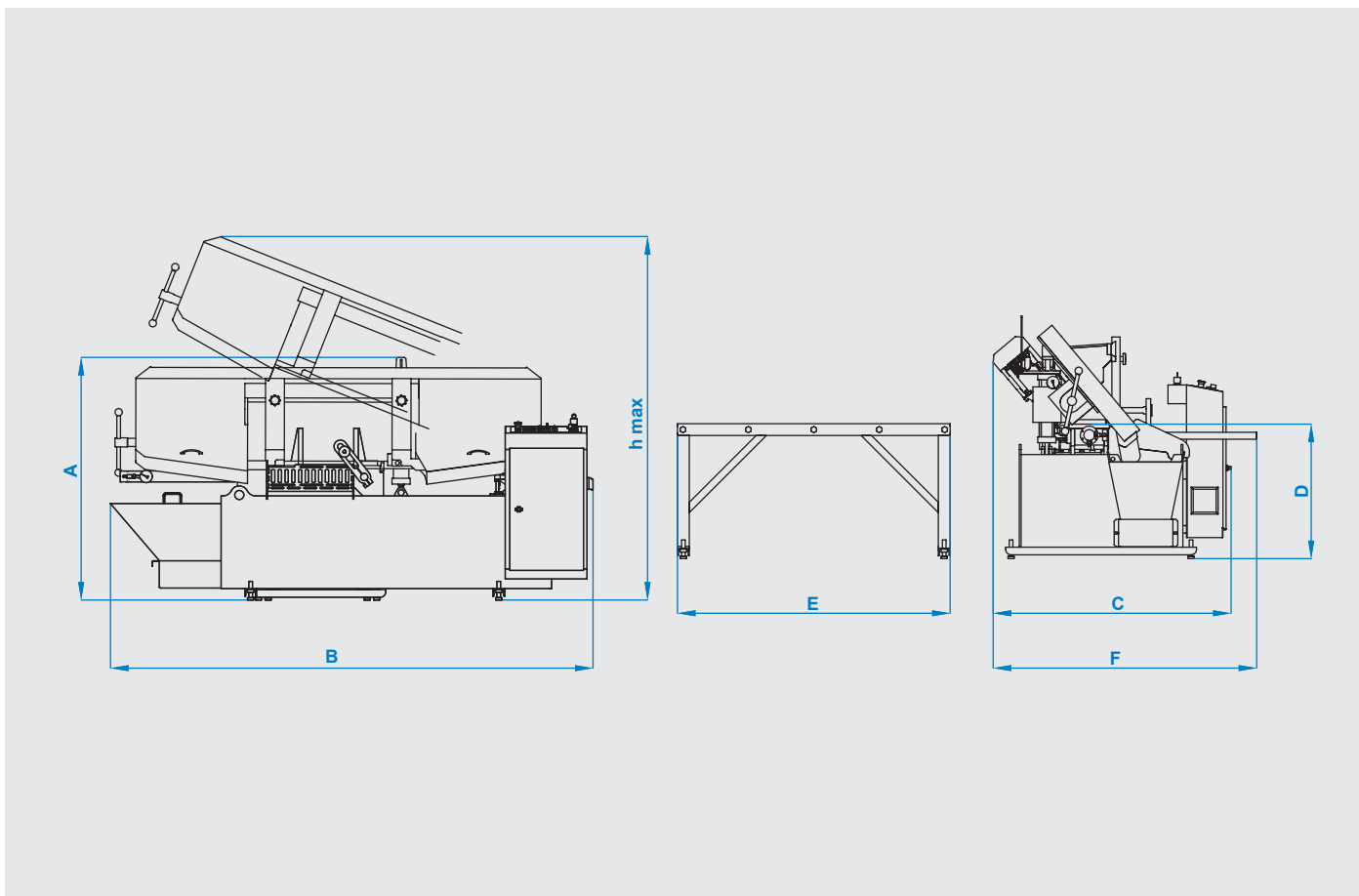



## ÖLÇÜLER DIMENSIONS



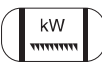
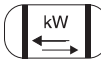
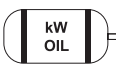
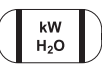

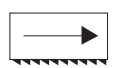

## MAFSALLI MODELLER PIVOT TYPES

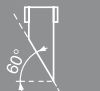

## TEKNİK ÖZELLİKLER / TECHNICAL FEATURES

A	1335 mm 52.56 inch	B	2655 mm 104.53 inch	C	1310 mm 51.57 inch	D	740 mm 29.13 inch	E	1500 mm 59.06 inch	F	1450 mm 57.09 inch	hmax	2000 mm 78.74 inch
---	-----------------------	---	------------------------	---	-----------------------	---	----------------------	---	-----------------------	---	-----------------------	------	-----------------------

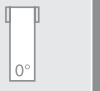
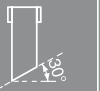
 Yarı Otomatik Semi Automatic	 Şerit Ölçüsü Blade Dimension 41 x 1.3 x 4635 mm 1 1/2 x 0.050 x 182.4 inch	 kW Şerit Motoru Blade Motor 4 kW - 1500 d/d 5.36 hp - 1500 rpm	 kW Sürücü Motor Feeding Motor Manuel Manual
 kW OIL Hidrolik Motor Hydraulic Pump Motor 0.75 kW - 1400 d/dk 1 hp - 1400 rpm	 kW H <sub>2</sub> O Soğutucu Motor Cooling Liquid Motor 0.12 kW - 3000 d/dk 0.16 hp - 3000 rpm	 Voltaj Voltage 400 V 400 V	 Maksimum Güç Maximum Power 4.87 kW 6.53 hp
 Kesme Hızı Cutting Speed 15 m/dk - 49 m/dk 100 m/dk - 328 ft/min	 KG LBS Ağırlık Weight 1200 kg 2645 lbs	 Malzeme Sıkma Sistemi Material Clamping System Hidrolik Hydraulic	 Şerit Germe Sistemi Blade Tensioning System Hidromekanik Hydramechanic

 Kesim Kapasitesi Cutting Capacity	 Kesim Kapasitesi Cutting Capacity	mm inch	 60°	 45°	 30°	 0°	 90°	 45°	 60°
350 mm 13.78 inch	400 mm 15.75 inch			300 mm 11.81 inch 280 x 280 mm 11.02 x 11.02 inch 200 x 300 mm 7.87 x 11.81 inch	350 mm 13.78 inch 350 x 350 mm 13.78 x 13.78 inch 260 x 350 mm 10.24 x 13.78 inch	350 mm 13.78 inch 350 x 350 mm 13.78 x 13.78 inch 210 x 400 mm 8.27 x 15.75 inch			